

Article number: 2310431133S

Description: E+G Levelling elements
LX.40-SW17-SST-M8X22-S

Measures

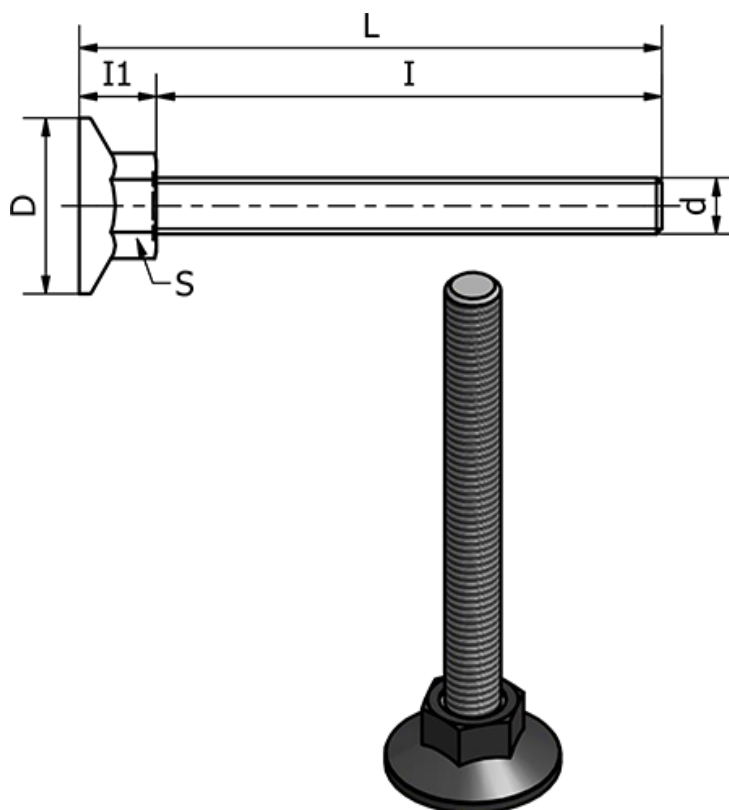

d = M8
D = 40
I = 22
I1 = 13
L = 34.5
S = 17

Static load in (N) = 2500

Type = AISI 304 Rustfast

Weight (g) = -